

THE INFLUENCE OF MICROSTRUCTURE ON FRACTURE TOUGHNESS OF VACUUM HEAT TREATED HSS AISI M2

VPLIV MIKROSTRUKTURE NA LOMNO ŽILAVOST VAKUUMSKO TOPLOTNO OBDELANEGA HITROREZNEGA JEKLA M2

Vojteh Leskovšek¹, Boris Ule¹, Božidar Lišič²

¹ Inštitut za kovinske materiale in tehnologije, Lepi pot 11, 1000 Ljubljana, Slovenija

² Fakulteta za strojništvo in ladjedelništvo, Ivana Lučića 5, 41000 Zagreb, Hrvatska
vojteh.leskovsek@imt.si

Prejem rokopisa - received: 2001-04-14; sprejem za objavo - accepted for publication: 2001-06-14

The microstructure of AISI M2 high-speed steel can be substantially modified by vacuum heat treatment in order to optimize the ratio between hardness and fracture toughness, which is, however, significantly affected by the volume fractions of retained austenite and undissolved eutectic carbides, as well as the mean distance between these carbides. Calculated fracture toughness values, which were obtained using a newly developed semi-empirical equation, based on the stress-modified critical strain criterion and the quantified microstructural parameters, agreed well with the experimental results.

Key words: vacuum heat treatment, high speed steel, quantified microstructural parameters, hardness and fracture toughness

Opisano je optimiranje vakuumske toplotne obdelave hitroreznega jekla M2. Po vakuumski toplotni obdelavi takšnega jekla je večji delež zaostalega avstenita, avstenitna zrna so večja njihove kristalne meja pa so močnejše markirane s precipitacijskimi karbidov, kot pa v primeru konvencionalne toplotne obdelave v solni kopeli. Volumski delež neraztopljenih evtektičnih karbidov v takšnem jeklu je odvisen le od temperature avstenitizacije. Mikrofraktografska opazovanja so pokazala, da je iniciranje loma v relativno trdem in krhkem hitroreznem jeklu poteka tudi z delno koalescenco mikropor. Lomno žilavost takšnega jekla smo opisali z modificirano obliko kritičnega napetostnega kriterija, ki upošteva tudi vpliv mikrostrukturnih parametrov: volumskega deleža neraztopljenih evtektičnih karbidov in srednje razdalje med njimi ter volumskega deleža zaostalega avstenita. Delež tega avstenita je numerično skoraj enak eksponentu deformacijskega utrjevanja jekla. Vpliv napetosti tečenja in lomne duktilnosti pa smo izrazili s trdoto jekla. Ker je velikost plastične cone pri merjenju lomne žilavosti tega jekla praviloma manjša od velikosti kristalnih zrn, le ta ne vplivajo na lomno žilavost. Izkazalo se je, da se z našo enačbo izračunane lomne žilavosti dobro ujemajo tako z našimi eksperimentalnimi podatki in z eksperimentalnimi podatki iz literature.

Ključne besede: hitrorezno jeklo, vakuumska toplotna obdelava, mikrostruktura, trdota, lomna žilavost, dimenzijske spremembe

1 INTRODUCTION

The vacuum heat treatment of high speed steels for cold working applications must satisfy ever greater demands regarding their exploitation, particularly in respect of greater toughness while maintaining or even increasing hardness, and in respect of the smallest possible dimensional changes of such tools. A high fracture toughness K_{Ic} means that these tools will be more resistant to shock loadings as well as to the propagation of fatigue cracks.

The microstructure of hot worked high speed steel, which has been vacuum quenched and tempered after annealing, consists of relatively large eutectic carbides in a martensitic matrix, hardened with finer secondary carbides. In the matrix, in which the eutectic carbides are distributed more or less in stringers, there is also some retained austenite. The fracture toughness of such steel is determined by the stress concentrators in the microstructure (e.g. carbides in stringers, carbide clusters, individual larger carbides, and non-metallic inclusions). When tools are subjected to loads, local stress concentrations occur next to the above-mentioned microstructure features which, if these stresses cannot be

released through microyielding of the matrix, accelerate tool breakage. By means of heat treatment, the microstructure of high speed steel can be changed, and, within fairly wide boundaries, the properties of the matrix, too. Due to secondary hardening under different tempering conditions, high speed steels having the same hardness but different microstructures and consequently different fracture toughnesses can be obtained, so that the optimisation of the heat treatment of high speed steels is a worthwhile task.

2 THEORY

The Rockwell C hardness as determined by a normal indentation test is primarily a feature of the matrix of high speed steel, provided that the indentation is not made at a position where carbide size or quantity is excessive. In the as-quenched condition, hardness may give some indication of the temperature from which the specimen has been quenched. In the tempered condition, hardness is essential from the user's viewpoint, although this value alone is not capable of differentiating between specimens hardened and tempered by different routes –

for example, similar hardness may be obtained by varying quenching and tempering temperatures, or merely by taking a tempering temperature either side of the peak secondary hardness value. For that reason beside of hardness an additional mechanical property such as fracture toughness K_{Ic} could be used for differentiation concerning the influence of vacuum heat treatment. Namely, fracture toughness tests on high speed steels show a better differentiation concerning the influence of heat treatment by the fracture toughness K_{Ic} than by the data of bend test¹.

An overview of the literature has shown that several different methods are used for measuring the fracture toughness of high speed steels. These include both standard methods, with the use of CT and SENB test specimens², and non-standard methods^{3...5}. Furthermore recently was, by the authors^{5...7}, developed semi-empirical equation where the fracture toughness of the high speed steel was quantified on the basis of microstructural parameters and several other material properties:

$$K_{Ic} = 1.363 \cdot \left(\frac{HRC}{HRC - 53} \right) \cdot \left[\sqrt{E \cdot d_p} \cdot (f_{carb})^{-\left(\frac{1}{6}\right)} \cdot (1 + f_{aust}) \right] \quad (1)$$

Since the above correlation is a semi-empirical one, and has been derived by taking into account, on the one hand, the critical strain criterion (McClintock⁸, Mackenzie et al⁹, Bates¹⁰, and Ritchie et al¹¹), and, on the other hand, the experimentally determined effects of the microstructural parameters and Rockwell C hardness, it is necessary to take all due care with units. The constant 1.363 was obtained by assuming that the modulus of elasticity E is expressed in MPa, the mean distance between undissolved eutectic carbides d_p in m, the Rockwell C hardness in units of HRC, and f_{carb} and f_{aust} as volume fractions of undissolved eutectic carbides and retained austenite. In this case the fracture toughness K_{Ic} is obtained in units of $\text{MPa}\sqrt{\text{m}}$.

From equation (1) it follows that the fracture toughness K_{Ic} of high speed steel depends not only on the latter's mechanical properties (apart from the modulus of elasticity, the fracture ductility and yield stress - both defined in terms of Rockwell C hardness, which means that the fracture ductility is inversely proportional to the hardness of the matrix and that the yield stress of the matrix is approximately proportional to hardness⁵⁻⁷) but also on several microstructural parameters (the volume fraction of undissolved eutectic carbides f_{carb} , the volume fraction of retained austenite f_{aust} - which affects the strain hardening exponent n - and the mean distance between the undissolved eutectic carbides, d_p), all of which depend on the vacuum heat treatment conditions. In the case of AISI M2 high speed steel, which contains a significant fraction of undissolved eutectic carbides, the mean distance between these carbides d_p can be calculated¹² from the following equation:

$$d_p = D_p \cdot (1 - f_{carb}) \cdot \sqrt{\frac{2}{3 \cdot f_{carb}}} \quad (2)$$

where f_{carb} is the volume fraction of undissolved eutectic carbides, and D_p is their mean diameter. However, importantly, the calculated fracture toughness values, which were derived using a newly developed semi-empirical equation, agreed well with the experimental results obtained by the authors, as well as with results obtained by other authors¹³.

3 EXPERIMENTAL PART

3.1 Choice of material and vacuum heat treatment.

In the experimental work, the ESR high speed steel AISI M2, delivered in the shape of rolled, soft annealed bars Φ 20 mm x 4000 mm, was used. This steel had the following chemical composition (mass content in %): 0.89 % C, 0.20 % Si, 0.26 % Mn, 0.027 % P, 0.001 % S, 3.91 % Cr, 4.74 % Mo, 1.74 % V, and 6.10 % W. The K_{Ic} test specimens, i.e. circumferentially notched and fatigue pre-cracked tensile test specimens made from these bars, were heat treated in a horizontal VTTC-324R vacuum furnace, with uniform high-pressure gas quenching, using N_2 at a pressure of up to 5 bars abs. An overview of the quenching and tempering temperatures, which were used in the experimental work described in this paper, is presented in **Table 1**.

Table 1: Overview of the quenching and tempering temperatures used in the vacuum furnace

Tabela 1: Pregled kalilnih in pouščnih temperatur uporabljenih v vakuumski peči

Group of K_{Ic} test specimens	Vacuum heat treatment conditions
A	1050/80/2x500 °C
B	1050/80/2x540 °C
C	1100/80/2x500 °C
D	1150/80/2x500 °C
E	1150/80/2x540 °C
F	1180/80/2x500 °C
G	1230/80/2x500 °C
H	1230/80/2x510 °C
I	1230/80/2x540 °C
J	1230/80/2x550 °C
K	1230/80/2x570 °C
L	1230/80/2x600 °C

For each set of vacuum heat-treatment conditions from A to G and I, at least 20 K_{Ic} test specimens were tested, the Rockwell C hardness and fracture toughness values being determined as described below. For each group of K_{Ic} test specimens from H and J to L, two K_{Ic} test specimens were tested.

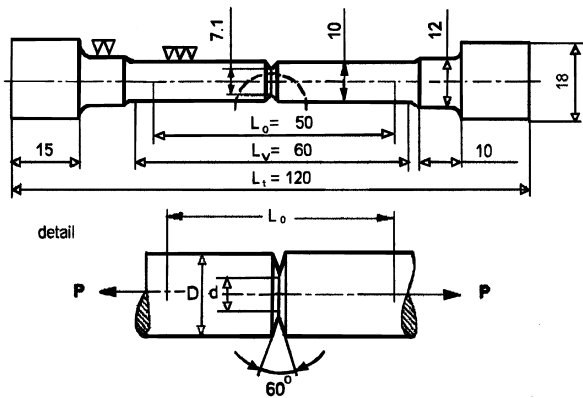

Figure 1: Circumferentially notched and fatigue pre-cracked K_{Ic} test specimen. All dimensions are given in mm

Slika 1: Cilindrični natezni preizkušavec z zarezo po obodu in utrujenostno razpoko v dnu zareze K_{Ic} preizkušavec. Vse dimenzije so v mm

3. 2 Hardness and fracture toughness tests

The measurements of Rockwell C hardness were performed on the individual groups of the K_{Ic} test specimens using a Wilson 4JR hardness machine.

In the case of the experimental work performed by the authors, circumferentially notched and fatigue pre-cracked tensile test specimens⁵⁻⁷ were machined, with the dimensions indicated in **Figure 1**.

The advantage of such test specimens over CT (compact tension) specimens lies in the former's radial symmetry, on account of which they are particularly suitable for studying the influence of the microstructure of metallic materials on their fracture toughness. This is because, due to the radial symmetry of the heat transfer, the formation of the microstructure is completely uniform.

Due to the high notch sensitivity of hard and brittle metallic materials, such as the high speed steel AISI M2, it is very difficult, and sometimes almost impossible, to create a fatigue crack in the corresponding test specimens. However, a fatigue crack can be created on such test specimens under a rotating-bending regime, if this is done before final heat treatment is performed^{35,36}. Another advantage of such test specimens is that plane strain conditions can be achieved while using specimens having smaller dimensions¹⁴ than is possible in the case of conventional CT test specimens. The critical stress intensity factor K_{Ic} was calculated from the equation developed by Parish and Sih⁴ as modified by Bueckner¹⁵ for a circumferentially notched round bar:

$$K_{Ic} = \frac{P}{D^{3/2}} \left(-1.27 + 1.72 \frac{D}{d} \right) \quad (3)$$

where P is the load at failure, D is the outside diameter, and d is the notched section diameter of the test specimen, i.e. the diameter of the ligament next to the

crack. The relationship (3) holds true as long as the condition $0.5 < d/D < 0.8$ is fulfilled.

3. 3 Microstructural and microfractographic tests

The microstructural tests were performed on the individual groups of K_{Ic} test specimens using, firstly, conventional optical metallographic techniques and a NIKON Microphoto-FXA optical microscope, and, secondly, a JEOL JSM-35 scanning electron microscope, which was also, used for the micrographic tests of the fracture surfaces of the K_{Ic} test specimens. The microstructures of the test specimens of the investigated, vacuum heat treated AISI M2 high speed steel were quantitatively evaluated¹⁶, using the following parameters: the mean diameter of the undissolved eutectic carbides, and the volume fractions of the individual microstructural phases (the undissolved eutectic carbides, the tempered martensite, and the retained austenite). The mean diameter D_p and volume fraction of the undissolved eutectic carbides $f_{carb} = (M_6C + MC)$ were determined on unetched metallographic specimens. SEM images of the microstructures were obtained with reflected electrons (BE)^{17,18}, at a magnification of M 1000 x. The images of 11 to 16 visible fields, obtained on each of the metallographic specimens of the investigated high speed steel, which had been vacuum quenched and tempered, were analysed using KS Lite V2.00 software for image analysis. From the images of the microstructure, obtained using the optical microscope at magnifications of M 600 x, of the same metallographic specimens, which had been etched for 2 to 3.5 minutes in a 5 % solution of nital with 10 % added HCl, and by means of image analysis using the KS Lite V2.00 software, the total volume fraction ($f_{carb} + f_{aust}$) of the undissolved eutectic carbides and of the retained austenite was determined. Eleven to twelve visible fields were analysed on each of the metallographic specimens of the investigated high speed steel. From the differences between the so determined total volume fraction of the undissolved eutectic carbides and the retained austenite (which appears white in the images obtained using the optical microscope) and the volume fraction of the undissolved eutectic carbides (SEM with reflected electrons), the volume fraction of the retained austenite in the investigated high speed steel was determined.

4. RESULTS AND DISCUSSION

It is well-known that the hardness of high speed steels varies according to composition, austenitizing temperature and time, and tempering temperature, and number of tempering operations. Different heat treatment processes (i.e. salt bath, fluidised bed or vacuum heat treatment) as well as microstructure has also an effect. **Figure 2** shows the effect of tempering temperature on secondary hardness peak of the

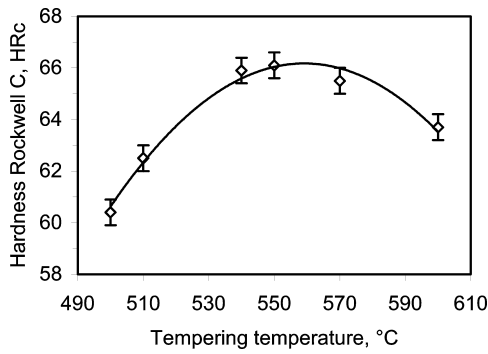

Figure 2: Influence of tempering temperature on secondary hardness peak of the investigated high speed steel. Vacuum austenitized 2 mins at 1230 °C and double tempered for 1 h. (measured on K_{Ic} test specimens from G to L; Table 1)

Slika 2: Vpliv temperature popuščanja na vrh sekundarnega utrjevanja pri preiskovanem hitroreznem jeklu. Vakuumsko avstenitiziran 2 min na 1230 °C in dvakratno popuščen po 1 h. (Merjeno na K_{Ic} preskušanih G do L, Tabela 1)

investigated vacuum heat treated high speed steel after double tempering.

The key problem in measuring fracture toughness of investigated high speed steel using circumferentially notched and fatigue pre-cracked tensile test specimens is linked with the disturbing effect of larger carbides or carbide clusters, which represent the weak spots on or near the fracture surface.

Analysis of the results of measurements of fracture toughness showed that the relationship between the calculated value of K_{Ic} using equation (3) and the radial distance x of the weak spot from the tip of the fatigue crack (see **Figure 3**) was a linear one (except for group G), so that the correct value of fracture toughness can be obtained simply, by linear extrapolation to $x = 0$ ⁵⁻⁷.

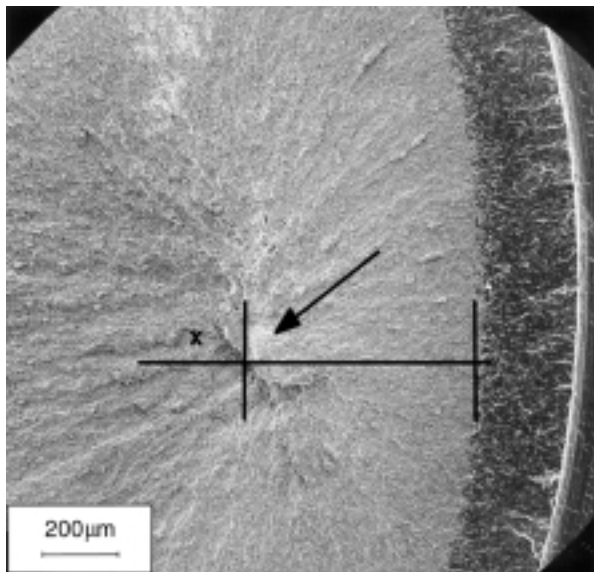

Figure 3: SEM image of a fracture surface containing a weak spot (K_{Ic} test specimen from group G)

Slika 3: SEM posnetek lomne površine s šibkim mestom (K_{Ic} preiskušane skupina G)

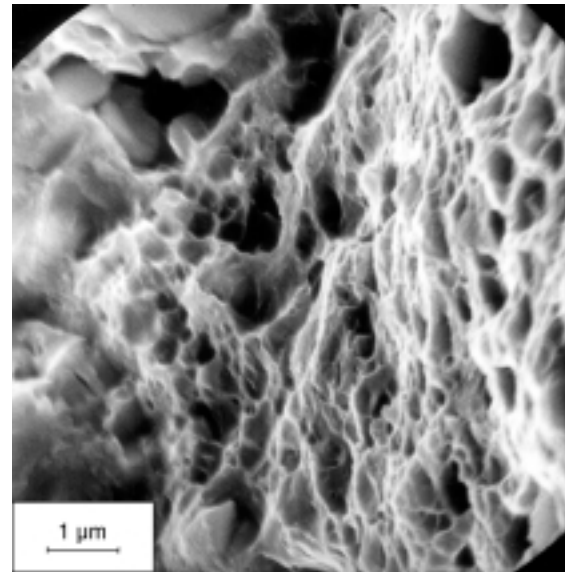

Figure 4: SEM image of an area of coalescence of microvoids at a weak spot of the K_{Ic} test specimen shown in **Figure 3**. Areas of transgranular fracture can also be seen (K_{Ic} test specimen from group G)

Slika 4: SEM posnetek področja s koalescenco mikropor na šibkem mestu K_{Ic} preiskušanca s slike 3. Vidno je tudi področje transgranularnega preloma (K_{Ic} preiskušanes skupina G)

Observation in the SEM of the weak spots on the fracture surfaces of the K_{Ic} test specimens, at high magnification, provided confirmation that such weak spots are characterised by the coalescence of microvoids (ductile regions) connected together by carbides or carbide clusters, as well as by characteristic tearing areas, where fracture in plastic shear had been initiated (see **Figure 4**).

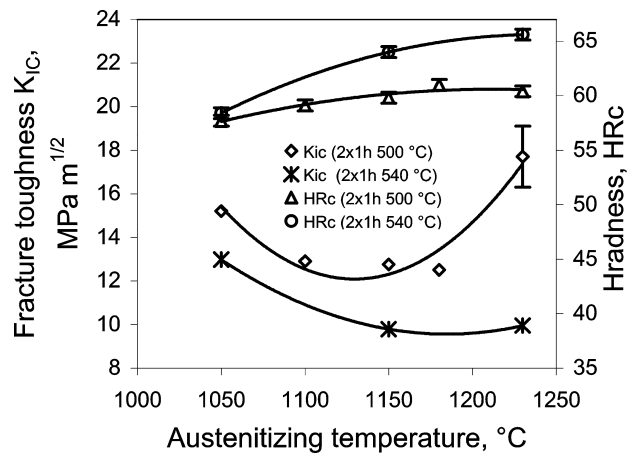

Figure 5: The influence of the temperature of austenitization on the hardness HRC and fracture toughness K_{Ic} of the investigated high speed steel, for two selected temperatures of tempering, for $\vartheta_p = 500$ °C and $\vartheta_p = 540$ °C (measured on K_{Ic} test specimens from A to G and I; Table 1)

Slika 5: Vpliv temperature avstenitizacije na trdoto in lomno žilavost preiskovanega hitroreznega jekla, po popuščanju 2 x 1h na temperaturi $\vartheta_p = 500$ °C oziroma $\vartheta_p = 540$ °C (Merjeno na K_{Ic} preiskušanih A do G in I; Tabela 1)

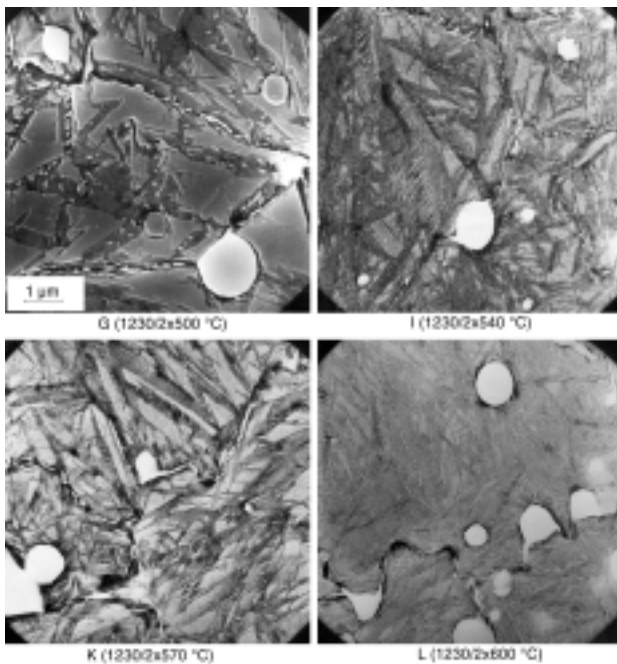

Figure 6: The microstructure of vacuum hardened and tempered K_{Ic} test specimens (set of vacuum heat-treatment conditions G, I, K and L, from Table 1)

Slika 6: Mikrostruktura vakuumsko kaljenih in popuščenih K_{Ic} preiskušancev (Pogoji vakuumske toplotne obdelave G, I, K in L; Tabela 1)

The results of the measurements of hardness and fracture toughness are shown, for the individual groups of K_{Ic} test specimens from A to G and I, in **Figure 5**.

From the diagram in Figure 5 it can be seen that the highest fracture toughness K_{Ic} of $17.7 \pm 1.4 \text{ MPa}\sqrt{\text{m}}$ and belonging hardness of $60.4 \pm 0.5 \text{ HRC}$ is achieved after vacuum quenching from austenitizing temperature of $1230 \text{ }^\circ\text{C}$ and double tempering for 1 hour at a temperature of $500 \text{ }^\circ\text{C}$. In examining the course of tempering, it is clear that fracture toughness K_{Ic} is a very selective mechanical property with regard to the temperature of austenitization and of tempering.

The microstructures of the investigated high speed steel (set of vacuum heat-treatment conditions G, I, K and L, from Table 1, respectively) examined by scanning electron microscope are shown in **Figure 6**.

As can be seen from micrographs in **Figure 6**, the microstructure of the investigated high speed steel consisting of tempered martensite and undissolved eutectic carbides. There is also retained austenite in the matrix, though less after double tempering at $570 \text{ }^\circ\text{C}$ (K), and more after double tempering at $500 \text{ }^\circ\text{C}$ (G). After double tempering at $600 \text{ }^\circ\text{C}$ (L) retained austenite in the matrix is no more visible. According to above micrographs it can be concluded that after vacuum quenching from $1230 \text{ }^\circ\text{C}$ and double tempering up to $570 \text{ }^\circ\text{C}$ retained austenite is very stable. In the case of the microstructure of the investigated high speed steel, which was quenched in the vacuum furnace from the

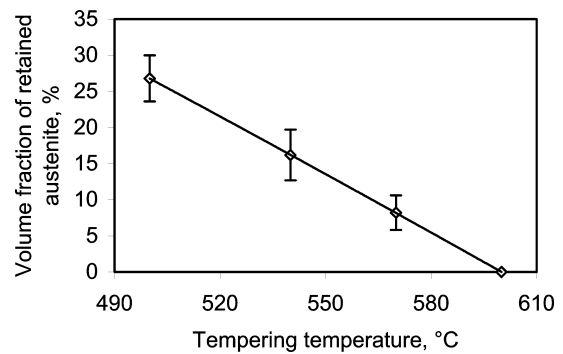

Figure 7: The influence of the tempering temperature on the volume fraction of the retained austenite of the investigated vacuum heat treated high speed steel. Vacuum austenitized 2 mins at $1230 \text{ }^\circ\text{C}$ (set of vacuum heat-treatment conditions G, I, K and L, from Table 1)

Slika 7: Vpliv temperature popuščenja na volumski delež zaostalega avstenita v preiskovanem vakuumsko toplotno obdelanem hitroreznem jeklu. Vakuumsko avstenitiziran 2 min na $1230 \text{ }^\circ\text{C}$ (skupine G, I, K in L; Tabela 1)

temperature of $1230 \text{ }^\circ\text{C}$, and double tempered for 1 hour at 500 , 540 , 570 and $600 \text{ }^\circ\text{C}$, respectively, the volume fraction of the retained austenite f_{aust} being determined as described above. The results of the determination of the volume fraction of the retained austenite are shown in **Figure 7**.

From the diagram in **Figure 7** it can be seen that in the case of the microstructure of the investigated high speed steel, which was vacuum quenched from $1230 \text{ }^\circ\text{C}$, and double tempered at $500 \text{ }^\circ\text{C}$, a relatively large volume fraction of stabilized retained austenite was obtained, amounting to approximately 25 to 30 vol. %, giving this steel its relatively high fracture toughness (see Figure 5). In this case a matrix hardness of 60.4 HRC still ensure a sufficiently high compressive yield stress $\sigma_{ys} = 1421 \text{ MPa}$.

Quantitative measurements of the mean diameter D_p and volume fraction of the undissolved eutectic carbides f_{carb} were determined on unetched metallographic specimens. Statistical analysis of the experimental results⁵ has shown that, in the case of the investigated high speed steel, the mean diameter D_p and volume fraction of the undissolved eutectic carbides mainly depend on austenitizing temperature and is practically independent of number of tempering cycles and tempering temperature. In this case - set of vacuum heat-treatment conditions G to L, from Table 1- the mean diameter of the undissolved eutectic carbides amount to $D_p = 0.94 \pm 0.1 \text{ } \mu\text{m}$, and volume fraction of these carbides amount to $f_{carb} = 6.7 \pm 1.4 \%$. The mean distance between these carbides d_p was calculated by mean of equation (2), and amount to $d_p = 2.8 \pm 0.6 \text{ } \mu\text{m}$.

From the results presented in ref.⁵⁻⁷ it can be seen that, for the investigated high speed steel, within the hardness range between 57 and 66 HRC, the measured and calculated values of fracture toughness K_{Ic} agree very well, the disagreement being less than 10 %, and

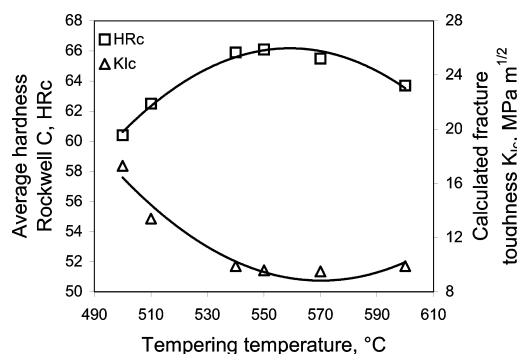

Figure 8: Effect of tempering temperature on hardness HRC and fracture toughness K_{Ic} of the investigated high speed steel. Fracture toughness K_{Ic} being calculate by mean of semi-empirical equation (1) for K_{Ic} test specimens from G to L, (see **Table 1**)

Slika 8: Vpliv temperature popuščanja na trdoto HRc in lomno žilavost K_{Ic} preiskovanega hitroreznega jekla. Lomne žilavosti K_{Ic} so izračunane s pomočjo enačbe (1) za K_{Ic} preiskušance skupin G do L (glej **Tabelo 1**)

the calculated values of fracture toughness K_{Ic} calculated from equation (1) are conservative when compared with the experimentally obtained values K_{Ic} . However, on the base of average measured hardness (see **Figure 2**) and above data obtained by quantitative metallography for the set of vacuum heat-treatment conditions G to L (see **Table 1**) by mean of semi-empirical equation (1) fracture toughness K_{Ic} was calculated, **Figure 8**. In all the calculations the average values of the volume fraction of the retained austenite f_{aust} , volume fraction of the undissolved eutectic carbides f_{carb} , mean distance between these carbides d_p and modulus of elasticity, amounting to $E = 2.17 \times 10^5$ MPa, has been taken into account.

By the comparison of experimentally obtained value of fracture toughness ($K_{Ic} = 17.7 \pm 1.4$ MPa \sqrt{m} ; **Figure 5**) and calculated value ($K_{Ic} = 17.3$ MPa \sqrt{m}) for the group of K_{Ic} test specimens G ($\vartheta_a = 1230$ °C; $\vartheta_p = 500$ °C), shown in **Figure 8**, one can find out that calculated value coincide very well with experimentally obtained. The same can be found out for the group of K_{Ic} test specimens I ($\vartheta_a = 1230$ °C; $\vartheta_p = 540$ °C), by the comparison of experimentally obtained value of fracture toughness ($K_{Ic} = 9.9$ MPa \sqrt{m}) and calculated value ($K_{Ic} = 9.9$ MPa \sqrt{m}). The excellent agreement between experimentally obtained values and the calculated ones is of course not unexpected since the same experimentally obtained values were used also for the calibration of equation (1). However the validity of equation (1) was additionally verified on the basis of results reported by Horton¹³. Taking into account his data¹³ for the conventionally manufactured high speed steel AISI M2, and vacuum heat treated at $\vartheta_a = 1220/80/2 \times 540$ °C, fracture toughness of $K_{Ic} = 15.9$ MPa \sqrt{m} is obtained, which agrees also very well with the value obtained by Horton experimentally, i.e. $K_{Ic} = 16.6$ MPa \sqrt{m} with belonging hardness of 64.0 HRc (**Table 11** in¹³). The above experimentally obtained and as well as

calculated value of fracture toughness shows that the conventional product has the superior K_{Ic} value in comparison with ESR product heat treated on the same hardness (see **Figure 5 and 8**). This is attributed to variations in mean distance between the undissolved eutectic carbides in relation to the size of the plastic zone ahead of a propagating crack.

In examining the course of tempering, it is found that there is a peak value of fracture toughness for a low tempering temperature ($\vartheta_p = 500$ °C) and a minimum corresponding to the hardness peak. This provides a strong indication that among others possible effects also differences in stabilised retained austenite (see **Figure 7**) cause the fracture toughness variations. Namely, the net effect of tempering is attributed to a combination of stress relief and a reduction in ductility due to the secondary hardening peak. From the diagram in **Figure 8** it can be clearly seen that in the case of the same obtained hardness the under-tempered K_{Ic} test specimens vacuum quenched from the same austenitizing temperature, achieve higher fracture toughness. For example, after vacuum quenching from 1230 °C and double tempering for 1hour at a temperature of 600 °C investigated high speed steel achieve hardness of 63,7 HRc and fracture toughness of $K_{Ic} = 9.9$ MPa \sqrt{m} , the same hardness but for ca. 30 % higher fracture toughness i.e. $K_{Ic} = 12.8$ MPa \sqrt{m} could be obtained after double tempering for 1hour at a temperature of 520 °C (see **Figure 8**). This could lead to the conclusion that high volume fraction of stabilized retained austenite in under-tempered investigated high speed steel (see **Figure 7**); significantly increase its fracture toughness.

Furthermore, good understanding of mutual interaction of mechanical and microstructural properties on fracture toughness K_{Ic} of investigated high speed steel as shown with the developed semi-empirical equation (1) gave us an opportunity of optimal choice of composition and manufacture of high speed steel (HIP'ed, forged, sintered, ESR or conventional material) as well as the choice of optimal heat treatment process (salt bath, fluidised bed or vacuum heat treatment) in the possibility of obtaining an optimum combination of basic characteristic of tools of high speed steels, and of the given working part – tool combination.

5 CONCLUSIONS

On the basis of the results of extensive tests performed on the ESR high-speed steel AISI M2, it has been confirmed that the microstructure of the investigated steel can be substantially modified by vacuum heat treatment in order to optimize the ratio between the hardness and fracture toughness K_{Ic} of this steel. It has also been experimentally proved that the volume fraction of retained austenite, the volume fraction of undissolved eutectic carbides, and the mean distance between the undissolved eutectic carbides all

have a significant effect on the measured fracture toughness K_{Ic} of this steel.

The semi-empirical correlation equation (1) derived by the authors for calculating the fracture toughness of tool steels such as the investigated high speed steel demonstrate that beside the increased amount of retained austenite stable after tempering (steel initially vacuum austenitized at highest temperature), fracture toughness is significantly influenced also by the mean distance of undissolved eutectic carbides, and thus, at given composition, by the carbide size.

After vacuum quenching of the investigated high speed steel from the highest recommended austenitizing temperature the volume fraction of undissolved eutectic carbides amounting to 6.7 %, their mean diameter to 0.94 μm and the mean distance between them to 2.8 μm . When a crack propagates in a material with such large undissolved eutectic carbides separated by large mean distance, large ligaments are left between the voids, which form at the individual carbides or carbide clusters. The plastic deformation of these ligaments is responsible for the energy dissipation that determines the crack resistance of the material. Therefore large undissolved eutectic carbides, with correspondingly large mean distance, give higher fracture toughness than smaller carbides.

It was also experimentally confirmed that in such a way vacuum heat treated investigated high speed steel have superior fracture toughness, especially at hardness below peak. This allows greater freedom in selecting desired combinations of hardness and toughness, especially in applications not requiring peak hardness.

6 REFERENCES

- ¹ Schmidt W.: T.E.T.B., 11, (1985) 2, 169-182
- ² ASTM E399-90: Standard Test Method for Plane-Strain Fracture Toughness of Metallic Materials
- ³ Fischmeister H.F.: Mater. Dev. (1982) 127/40
- ⁴ Parish P.G.; Sih G.C.: ASTM-STP318 (1965) 30
- ⁵ Leskovšek V.: Optimization of the vacuum heat treatment of high speed steels, University of Zagreb, 1999 (Ph.D. thesis)
- ⁶ Ule B.; Leskovšek V.; Tuma B.: Accepted for publication in Engineering Fracture Mechanics, Editorial reference EFM-0254-99-KHS
- ⁷ Leskovšek V, Ule B., Liščić B.: A paper to be published in Steel Research
- ⁸ McClintock F.A.: J.Applied Mech., Trans. ASME Series E 35 (1968) 363/71
- ⁹ Mackenzie A.C.; Hancock J.W.; Brown D.K.: Eng. Fract. Mech. 9 (1977) 167/88
- ¹⁰ Bates R.C., in Metallurgical Treatises, Eds.: Tien J.K., Elliot J.F., TMS-AIME, Warrendale, PA, 1982, 551/70
- ¹¹ Richie R.O.; Selver W.L.; Wullaert R.A.: Metall. Trans. 10A (1979) 1557/70
- ¹² Edelson B.I.; Baldwin W.M., Jr.: Trans. ASM 55, 230 (1962) 230/50
- ¹³ Horton S.A.: The Relationship of Segregation Structure and Properties in High Speed Steels, University of Aston in Birmingham, 1980 (Ph. D. thesis)
- ¹⁴ Shen Wei; Zhao Tingshi; Gao Daxing; Liu Dunkang; Li Poliang; Qiu Xiaoyun: Eng. Fract. Mech. 16, (1982) 1, 69/92
- ¹⁵ Bueckner H.F.: ASTM-STP 381 (1965), 82
- ¹⁶ Vander Voort G.F.: Metallography, McGraw-Hill Book Company, New York, USA, 1984
- ¹⁷ Vodopivec F.; Jakupovič M.: Železarski Zbornik 13, (1979) 1, 69/76.
- ¹⁸ Karagöz S.; Fischmeister H.: Steel research 58, (1987) 1, 46/51.