

COMPARISON OF STEEL AND ALUMINIUM BEHAVIOUR AS MATERIALS FOR RINGS AND WHEELS

PRIMERJAVA JEKLA IN ALUMINIJA KOT MATERIALOV ZA OBROČE IN KOLES

EVGENY VASILJEVICH BINKEVICH¹, V. B. SHYNKARENKO¹,
F. VODOPIVEC², I. MAMUŽIČ³

¹Dniepropetrovsk State University, Dniepropetrovsk, Ukraine

²Institute of metals and technology, Ljubljana, Slovenia

³Metallurgical faculty, University of Zagreb, Croatia

Prejem rokopisa - received: 1998-11-25; sprejem za objavo - accepted for publication: 1998-12-07

A two-layer ring of various thickness from steel and aluminium and a wheel in the shape of steel ring with steel or aluminium spokes were analysed by the FEM. In the first problem the plasticity of material was considered, and in the second, also- the possibility of spokes buckling. Conclusions about the efficiency of use of steel and aluminium in loaded elements of thinwalled structures are made.

Key words: wheels, steel, aluminium, finite elements, strength, buckling

Dvoslojni obroč različne debeline iz jekla in kolo z jeklenim obročem in z jeklenimi ali aluminijastimi špicami sta bila analizirana po metodi FEM. V prvem primeru je bila upoštevana plastičnost materiala in v drugem tudi uklon špic. Oblikovani so zaključki o učinkovitosti uporabe jekla in aluminija v obremenjenih tankostenih strukturah.

Ključne besede: kolo, jeklo, aluminij, končni elementi, trdnost, uklon

1 INTRODUCTION

Up to recent years, steel was the main material used in loaded elements of engineering structures. In the latest decades the intensive development of material science and technology has increased the use of other structural materials, such as aluminium, polymers, and ceramics. Therefore, the answer to the question in which kind of structures aluminium alloys could economically and reliably replace steel, is of great interest.

A tentative answer to this question, based on data on the growth of steel production and the improvement of its properties, is given in ref. 1. The conclusion is that steel will remain the main material in modern industry because of the technological progress achieved during last years, the reduction of manufacturing costs, the ecological friendliness, and the great possibilities to improve such properties of steel as strength, rigidity, fatigue limit, resistance to corrosion and their combinations. It will, however, be forced to compete in some uses with aluminium alloys and polymers.

In this paper the question of selection of materials for loaded elements of structures is considered through the analysis of particular structures. Two problems are chosen for investigation: a two-layer steel-aluminium ring and a steel wheel with steel or aluminium spokes. The following materials are used²: a high-strength steel with ultimate stress $\sigma_{st}^u = 1400$ MPa, yield stress $\sigma_{st}^y = 1200$ MPa, elastic module $E_{st} = 2.10^5$ MPa, Poisson ratio $\nu_{st} = 0.3$, and density $\rho_{st} = 78500$ N/m³, and an aluminium al-

loy with $\sigma_{al}^u = 490$ MPa, $\sigma_{al}^y = 330$ MPa, $E_{al} = 0.7.10^5$ MPa, $\nu_{al} = 0.31$, and $\rho_{al} = 27500$ N/m³.

The finite element analysis is carried out on the base of quadratic 3-node bar and beam elements, falling in a class of isoparametric degenerate finite elements^{3,4}, in which partially orthogonal shape functions⁵ are used. Elastic-plastic properties of material are taken into account using the flow theory and the Mises yield criterion.

2 ANALYSIS OF TWO-LAYER RING

The first structure is a ring radius $R = 0.2$ m, width $b = 0.01$ m and thickness $h = 0.02$ m, loaded on the top point by the force P and supported in the bottom (**figure 1**) and consisting of an outer steel layer of thickness h_{st} and an aluminium inner layer of thickness $h_{al} = h - h_{st}$. Because of the symmetry half of the ring is considered, which is divided into 20 reduced-integrated finite elements each with 8 integration points in the through thickness direction.

In **figure 2** the diagrams of deformation of the ring, the unitless load $PR^2/E_{st}I$ as a function of the unitless deflection Δ/R , are presented at various values of the steel layer thickness versus the total ring thickness ratio. The value I is the ring-section moment of inertia, and Δ is the vertical displacement of the loaded point. The case of $h_{st}/h = 1$ corresponds to a steel ring and the case of $h_{st}/h = 0$ to an aluminium ring.

In **figure 3** the distribution of unitless bending moment $100.MR/E_{st}I$ along the ring circumference is shown

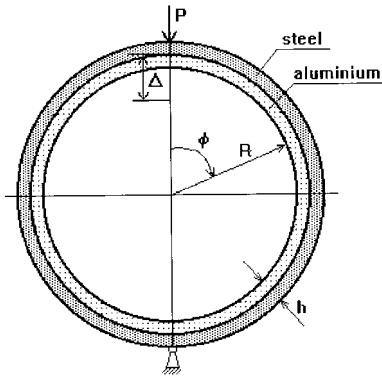

Figure 1: A two-layer ring under concentrated load
Slika 1: Dvoslojni obroč s koncentričnim bremenom

at various values of the steel layer thickness versus the total ring thickness ratio h_{st}/h .

In **figure 4** the ratio of volume and weight of a steel-aluminium ring (V and W) and an aluminium ring (V' and W') as a function of the ratio of the steel layer thickness h_{st} and the total thickness h at fixed force $P = 6.25$ kN and deflection $\Delta = 0.03$ m are shown. From the obtained results it can be concluded that though by the same ring deformation the weight of a steel ring is 1.6 times greater than of an aluminium ring, its volume is 1.78 times smaller. This is a consequence of the fact that the greater is the steel fraction in ring thickness the greater is the total ring stiffness and smaller - the total ring thickness (the total ring volume) at fixed limit load. But as the steel density is greater than that of aluminium, the ring weight grows when the h_{st}/h ratio grows.

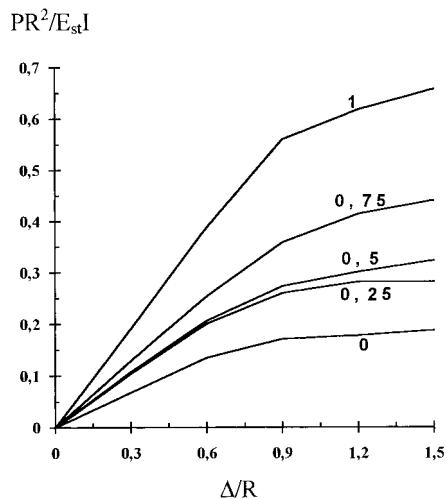

Figure 2: Unitless load in dependence on unitless deflection at various values of the steel layer thickness versus the total ring thickness ratio h_{st}/h ; P is the value of external load, R - ring radius, E_{st} - elastic module of steel, I - ring cross-section moment of inertia, Δ - vertical displacement of the loaded point

Slika 2: Razmerje z dimenzijsko breme brezdimenzijskega upogiba pri različnih debelinah jeklene plasti v odvisnosti od razmerja skupne debeline obroča h_{st}/h ; P - zunanje breme, R - polmer obroča, E_{st} - elastični modul jekla, I - vstrajnostni moment preseka obroča, Δ - vertikalni upogib obremenjene točke

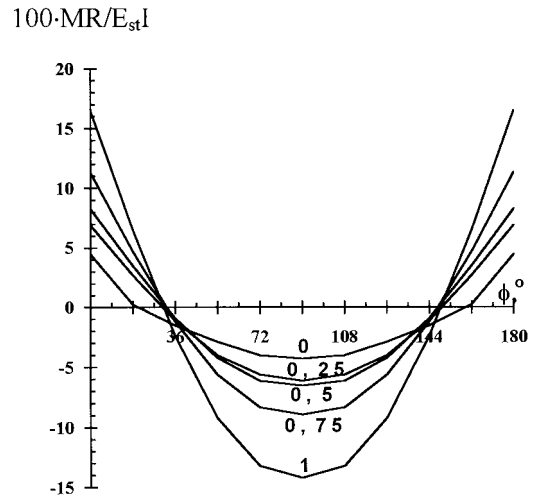

Figure 3: Distribution of unitless bending moment along the ring circumference at various values of the steel layer thickness versus the total ring thickness ratio h_{st}/h ; M is the value of bending moment, R - ring radius, E_{st} - elastic module of steel, I - ring cross-section moment of inertia

Slika 3: Porazdelitev brezdimenzijskega upogibnega momenta vzdolž oboda obroča pri različnih debelinah jeklene sloja v odvisnosti od razmerja skupne debeline obroča h_{st}/h ; M - upogibni moment, R - polmer obroča, E_{st} - modul elastičnosti jekla, I - vstrajnostni moment preseka obroča

3 ANALYSIS OF A RING WITH SPOKES

The next test structure was a steel wheel of radius $R = 0.2$ m, width $b = 0.01$ m and thickness $h = 0.01$ m with steel or aluminium spokes of square cross-section and width w). On the bottom the wheel is supported and in the wheel centre a vertical force P is applied, as shown in **figure 5** for a wheel with 6 spokes. The calculation is performed for the case of spokes placed symmetrically to the supporting point in their middle. Elastic-plastic properties of the material are considered, as well as the pos-

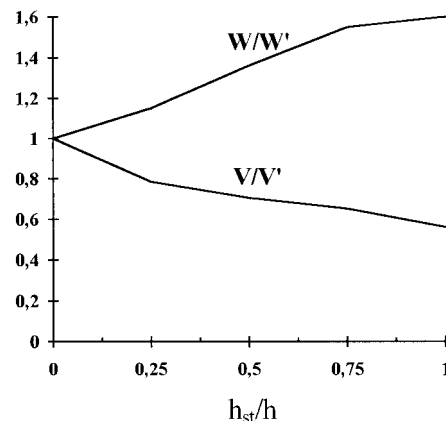

Figure 4: Ratio of volume and weight of a two layer ring (V and W) and an aluminium ring (V' and W') as a function of the ratio h_{st}/h at fixed load $P = 6.25$ kN and deflection $\Delta = 0.03$ m

Slika 4: Razmerje med volumnom in težo dvoslojnega obroča (V and W) in aluminijastega obroča (V' and W') v odvisnosti od razmerja h_{st}/h pri stalnem bremenu $P = 6.25$ kN in upogibu $\Delta = 0.03$ m

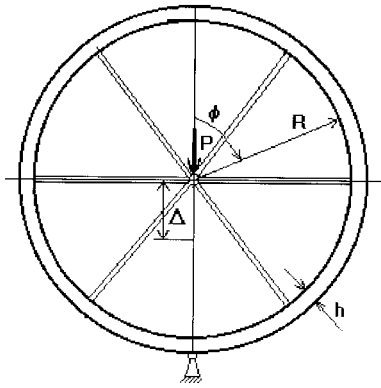

Figure 5: A steel wheel with steel or aluminium spokes
Slika 5: Jekleno kolo z aluminijastimi špicami

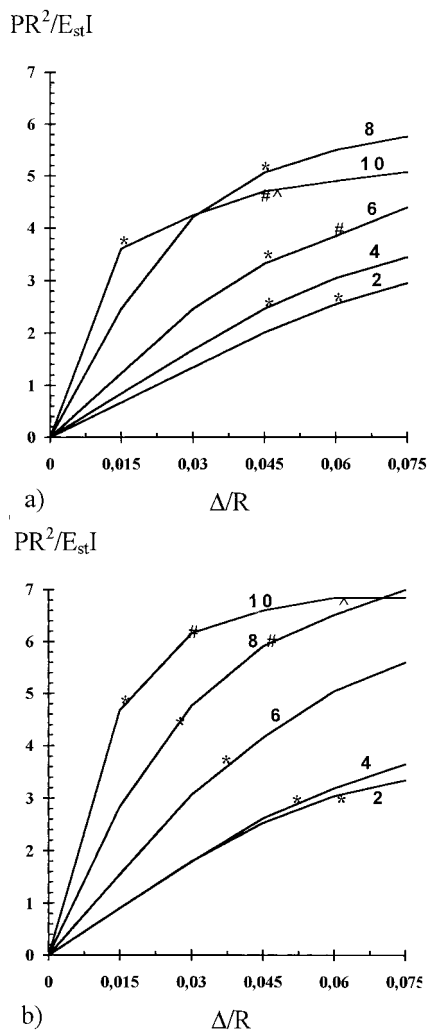

Figure 6: Unitless load in dependence on unitless deflection for various quantity of aluminium (a) and steel (b) spokes. The ring thickness was set constant and the spokes width was selected inversely proportional to their number. The symbol * labels the beginning of plastic flow of the ring, the symbol ^ - the same for spokes, the symbol # - buckling of the bottom spoke

Slika 6: Brezdimenzijsko breme v odvisnosti od števila aluminijastih (a) in jeklenih (b) špic. Predpostavljena je konstantna debelina obroča, širina špic pa je obratno sorazmerna z njihovim številom. Označba * pomeni začetek plastičnega tečenja obroča, označba ^ - isto za špice in označba # - uklon spodnje špice

sibility of spokes buckling. When the compression stress in a spoke achieves the critical value according to the Euler formula², it remains constant at further spoke deformation.

Figure 6 shows the diagrams of deformation of a steel wheel, unitless external load $PR^2/E_{st}I$ in dependence of unitless displacement Δ/R of wheel centre, for various numbers of aluminium (figure 6a) and steel (figure 6b) spokes. The symbol * denotes the moment when plastic flow of the ring begins, the symbol ^ denotes the same for spokes (appearance of plastic deformation in the second spoke from the ring bottom), and the symbol # the moment of buckling of the bottom spoke. The ring thickness was set constant during changing the number of spokes, and the spokes width w was selected as inversely proportional to their number.

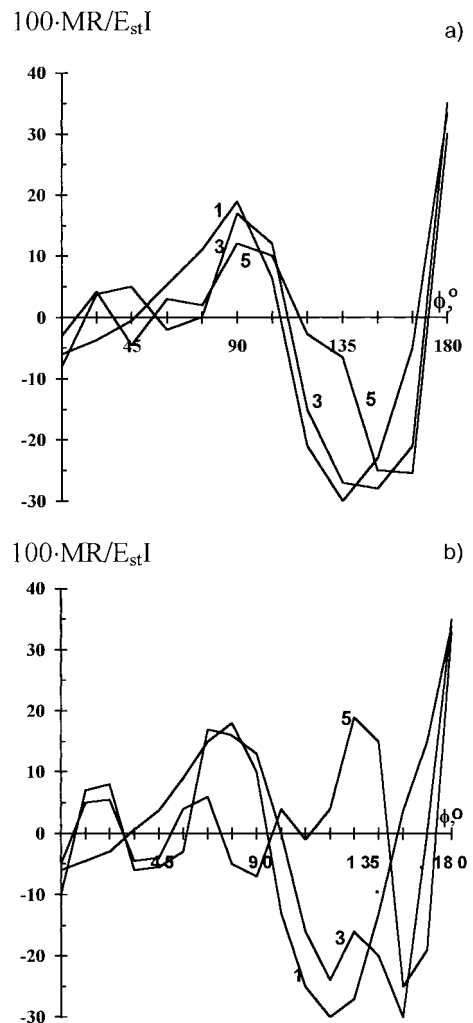

Figure 7: Distribution of unitless bending moment along the wheel circumference at various numbers of aluminium (a) and steel (b) spokes. M is the value of bending moment, R - ring radius, E_{st} - elastic module of steel, I - ring cross-section moment of inertia

Slika 7: Porazdelitev brezdimenzijskega upogibnega momenta vzdolž oboda kolesa za različno število špic iz aluminija (a) in jekla (b). M - upogibni moment, R - premer obroča, E_{st} - elastični modul jekla, I - vstrajnostni moment preseka obroča

Table 1: "Ultimate load" (corresponding to the displacement $\Delta = 0.015$ m) for a wheel having a) aluminium spokes, b) steel spokes of the same size and c) steel spokes with the width reduced to obtain such maximal load as for aluminium spokes

Material and number of spokes	Unitless width of the spoke cross-section w/R	Unitless "ultimate load" $PR^2/E_{st}I$
a) Aluminium	2	3.44
	4	2.95
	6	4.39
	8	5.76
	10	5.07
b) Steel	2	3.37
	4	3.64
	6	5.40
	8	7.00
	10	6.86
c) Steel	2	3.28
	4	3.02
	6	4.63
	8	5.63
	10	3.64

In **table 1** the values of the "ultimate load", defined as the force P corresponding to the deflection $\Delta = 0.015$ m, are presented for various numbers of spokes. The first group of data, shown also in **figure 6a**, concerns aluminium spokes, the second, shown also in **figure 6b**, concerns steel spokes of the same section, and the third - the case of steel spokes with the thickness reduced in order to obtain the maximal value of P equal to the case of aluminium spokes. According to the calculated data, at the same value of "ultimate load" the weight of a wheel

with steel spokes is 1.38 times greater, and the volume - 1.37 time smaller, than for a ring with aluminium spokes. The results in the **table 1** are shown for the number of spokes from 2 to 10. Further increasing of the number of spokes does not increase the "ultimate load" because of the early onset of spokes buckling.

4 CONCLUSIONS

Strength criteria show that the use of steel wheels appears more efficient than that of aluminium wheels in a structure, for which the volume of loaded elements is more important factor than the weight. A large part of stable structures falls into this category, except for such specific cases as flying vehicles. Although only strength of steel and aluminium are considered, it can be expected that the results will remain valuable also for more complex structures and in the case when all of properties of both materials will be considered.

5 REFERENCES

- ¹ F. Vodopivec: Steel, the material for the 21th century, *Metalurgija*, 35 (1996) 2, 87-91
- ² G. S. Pisarenko, A. P. Yakovlev, V. V. Matveev: Handbook on the strength of materials (in Rus.), Kiev, Naukova dumka, 1988, 738
- ³ D. R. J. Owen, E. Hinton: Finite elements in plasticity: Theory and practice, Swansea, Pineridge Press, 1980, 502
- ⁴ I. Mamuzich, A. A. Komarov, V. B. Shynkarenko: Finite elements for analysis of sheet forming processes, *Metalurgija*, 35 (1996) 3, 139-144
- ⁵ I. Mamuzich, V. B. Shynkarenko, I. V. Binkevich: Finite elements stiffness matrices conditionality improvement in analysis of metal forming processes via orthogonalization of shape functions, *Metalurgija*, 35 (1996) 2, 79-82